

CSD87333Q3D 同步降压 NexFET™ 电源块

1 特性

- 半桥电源块
- 针对高占空比进行了优化
- 高达 $24 V_{in}$
- 电流 8A 时，系统效率达到 94.7%
- 电流 8A 时， P_{Loss} 1.5W
- 工作电流高达 15A
- 高频工作（高达 1.5MHz）
- 高密度小外形尺寸无引线 (SON) 3.3mm x 3.3mm 封装
- 针对 5V 栅极驱动进行了优化
- 开关损耗较低
- 超低电感封装
- 符合 RoHS 环保标准
- 无卤素
- 无铅引脚镀层

2 应用范围

- 同步降压转换器
 - 高频 应用
 - 高占空比 应用
- 同步升压转换器
- 负载点 (POL) 直流 - 直流转换器

3 说明

CSD87333Q3D NexFET™ 电源块是面向同步降压和升压应用的优化设计方案，能够以 3.3mm x 3.3mm 的小巧外形提供高电流、高效率以及高频率性能。该产品针对 5V 栅极驱动应用进行了优化，在与外部控制器或驱动器配合使用时，可在高占空比应用中提供灵活的解决方案

俯视图

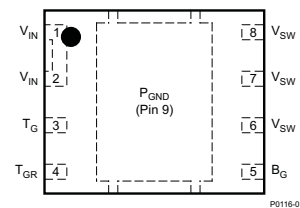

器件信息⁽¹⁾

器件	包装介质	数量	封装	运输
CSD87333Q3D	13 英寸卷带	2500	SON 3.30mm x 3.30mm 塑料封装	卷带封装
CSD87333Q3DT	7 英寸卷带	250		

(1) 要了解所有可用封装，请见数据表末尾的可订购产品附录。

典型电路

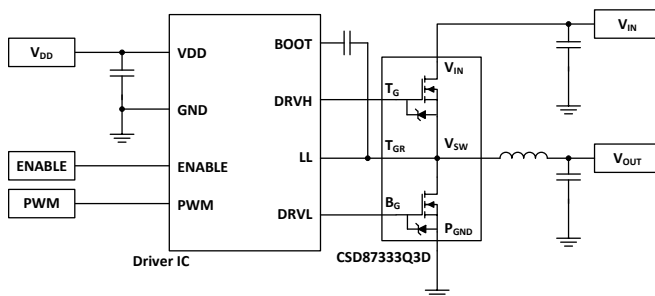

典型电源块效率与功率损耗

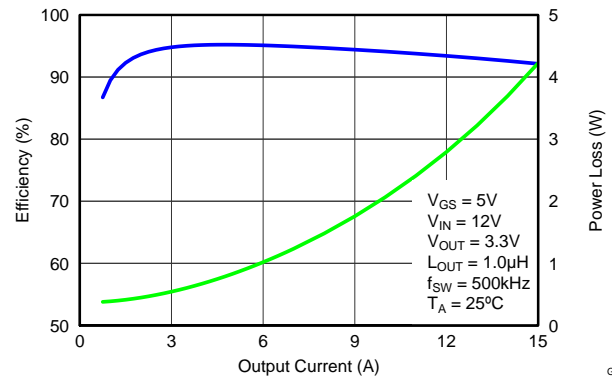

G001



目录

1	特性	1	6.4	Calculating Power Loss and SOA.....	10
2	应用范围.....	1	7	Recommended PCB Design Overview	11
3	说明.....	1	7.1	Electrical Performance.....	11
4	修订历史记录	2	7.1	Thermal Performance	12
5	Specifications	3	8	器件和文档支持	13
5.1	Absolute Maximum Ratings	3	8.1	接收文档更新通知	13
5.2	Recommended Operating Conditions.....	3	8.2	社区资源.....	13
5.3	Power Block Performance	3	8.3	商标	13
5.4	Thermal Information	3	8.4	静电放电警告.....	13
5.5	Electrical Characteristics.....	4	8.5	Glossary	13
5.6	Typical Power Block Device Characteristics.....	5	9	机械、封装和可订购信息	14
5.7	Typical Power Block MOSFET Characteristics.....	7	9.1	Q3D 封装尺寸	14
6	Applications	9	9.2	引脚布局配置.....	15
6.1	Power Loss Curves.....	9	9.3	焊盘布局建议.....	16
6.2	Safe Operating Area (SOA) Curves.....	9	9.4	模板建议.....	16
6.3	Normalized Curves.....	9	9.5	Q3D 卷带信息	17

4 修订历史记录

Changes from Original (February 2014) to Revision A	Page
• Added pulse duration note to I_{DM} in the <i>Absolute Maximum Ratings</i> table.....	3
• 已添加 接收文档更新通知部分和社区资源部分至器件和文档支持部分	13

5 Specifications

5.1 Absolute Maximum Ratings⁽¹⁾

 $T_A = 25^\circ\text{C}$ (unless otherwise noted)

PARAMETER	CONDITIONS	MIN	MAX	UNIT
Voltage	V_{IN} to P_{GND}	-0.8	30	V
	V_{SW} to P_{GND}		30	V
	V_{SW} to P_{GND} (10 ns)		32	V
	T_G to T_{GR}	-0.3	10	V
	B_G to P_{GND}	-0.3	10	V
Pulsed current rating, I_{DM} ⁽²⁾			40	A
Power dissipation, P_D			6	W
Avalanche energy, E_{AS}	Sync FET, $I_D = 19$, $L = 0.1$ mH		18	mJ
	Control FET, $I_D = 19$, $L = 0.1$ mH		18	
Operating junction temperature, T_J		-55	150	$^\circ\text{C}$
Storage temperature, T_{stg}		-55	150	$^\circ\text{C}$

- (1) Stresses beyond those listed under *Absolute Maximum Ratings* may cause permanent damage to the device. These are stress ratings only, and functional operation of the device at these or any other conditions beyond those indicated in the *Recommended Operating Conditions* is not implied. Exposure to absolute-maximum-rated conditions for extended periods may affect device reliability.
- (2) Pulse duration ≤ 50 μs . Duty cycle $\leq 0.01\%$.

5.2 Recommended Operating Conditions

 $T_A = 25^\circ\text{C}$ (unless otherwise noted)

PARAMETER	CONDITIONS	MIN	MAX	UNIT
V_{GS} Gate drive voltage		3.3	8	V
V_{IN} Input supply voltage			24	V
f_{SW} Switching frequency	$C_{BST} = 0.1$ μF (min)		1500	kHz
Operating current			15	A
T_J Operating temperature			125	$^\circ\text{C}$

5.3 Power Block Performance⁽¹⁾

 $T_A = 25^\circ\text{C}$ (unless otherwise noted)

PARAMETER	CONDITIONS	MIN	TYP	MAX	UNIT
P_{LOSS} Power loss ⁽¹⁾	$V_{IN} = 12$ V, $V_{GS} = 5$ V, $V_{OUT} = 3.3$ V, $I_{OUT} = 8$ A, $f_{SW} = 500$ kHz, $L_{OUT} = 1$ μH , $T_J = 25^\circ\text{C}$		1.5		W
I_{QVIN} V_{IN} quiescent current	T_G to $T_{GR} = 0$ V B_G to $P_{GND} = 0$ V		10		μA

- (1) Measurement made with six 10- μF (TDK C3216X5R1C106KT or equivalent) ceramic capacitors placed across V_{IN} to P_{GND} pins and using a high current 5-V driver IC.

5.4 Thermal Information

 $T_A = 25^\circ\text{C}$ (unless otherwise stated)

THERMAL METRIC		MIN	TYP	MAX	UNIT
$R_{\theta JA}$	Junction-to-ambient thermal resistance (min Cu) ⁽¹⁾			150	$^\circ\text{C}/\text{W}$
	Junction-to-ambient thermal resistance (max Cu) ⁽¹⁾⁽²⁾			80	
$R_{\theta JC}$	Junction-to-case thermal resistance (top of package) ⁽¹⁾			36	$^\circ\text{C}/\text{W}$
	Junction-to-case thermal resistance (P_{GND} pin) ⁽¹⁾			3.7	

- (1) $R_{\theta JC}$ is determined with the device mounted on a 1-in² (6.45-cm²), 2-oz (0.071-mm) thick Cu pad on a 1.5-in \times 1.5-in (3.81-cm \times 3.81-cm), 0.06-in (1.52-mm) thick FR4 board. $R_{\theta JC}$ is specified by design while $R_{\theta JA}$ is determined by the user's board design.
- (2) Device mounted on FR4 material with 1-in² (6.45-cm²) Cu.

5.5 Electrical Characteristics

 $T_A = 25^\circ\text{C}$ (unless otherwise stated)

PARAMETER	TEST CONDITIONS	Q1 Control FET			Q2 Sync FET			UNIT
		MIN	TYP	MAX	MIN	TYP	MAX	
STATIC CHARACTERISTICS								
BV_{DSS}	Drain-to-source voltage	$V_{GS} = 0\text{ V}, I_{DS} = 250\ \mu\text{A}$			30			V
I_{DSS}	Drain-to-source leakage current	$V_{GS} = 0\text{ V}, V_{DS} = 20\text{ V}$			1			μA
I_{GSS}	Gate-to-source leakage current	$V_{DS} = 0\text{ V}, V_{GS} = +10 / -8\text{ V}$			100			nA
$V_{GS(th)}$	Gate-to-source threshold voltage	$V_{DS} = V_{GS}, I_{DS} = 250\ \mu\text{A}$			0.75	0.95	1.20	V
$R_{DS(on)}$	Drain-to-source on resistance	$V_{GS} = 3.5\text{ V}, I_{DS} = 4\text{ A}$			14.7	17.7	17.7	m Ω
		$V_{GS} = 4.5\text{ V}, I_{DS} = 4\text{ A}$			13.4	16.1	16.1	
		$V_{GS} = 8\text{ V}, I_{DS} = 4\text{ A}$			11.9	14.3	14.3	
g_{fs}	Transconductance	$V_{DS} = 15\text{ V}, I_{DS} = 4\text{ A}$			43			S
DYNAMIC CHARACTERISTICS								
C_{ISS}	Input capacitance	$V_{GS} = 0\text{ V}, V_{DS} = 15\text{ V}, f = 1\text{ MHz}$			509	662	662	pF
C_{OSS}	Output capacitance				222	289	289	pF
C_{RSS}	Reverse transfer capacitance				8.2	10.7	10.7	pF
R_G	Series gate resistance				3.4	6.8	6.8	Ω
Q_g	Gate charge total (4.5 V)	$V_{DS} = 15\text{ V}, I_{DS} = 4\text{ A}$			3.5	4.6	4.6	nC
Q_{gd}	Gate charge gate-to-drain				0.3	0.3	0.3	nC
Q_{gs}	Gate charge gate-to-source				1.6	1.6	1.6	nC
$Q_{g(th)}$	Gate charge at V_{th}				0.6	0.6	0.6	nC
Q_{OSS}	Output charge				$V_{DS} = 15\text{ V}, V_{GS} = 0\text{ V}$			5.3
$t_{d(on)}$	Turnon delay time	$V_{DS} = 15\text{ V}, V_{GS} = 4.5\text{ V}, I_{DS} = 4\text{ A}, R_G = 2\ \Omega$			2.1	2.1	2.1	ns
t_r	Rise time				3.9	3.9	3.9	ns
$t_{d(off)}$	Turnoff delay time				9.4	9.4	9.4	ns
t_f	Fall time				2.2	2.2	2.2	ns
DIODE CHARACTERISTICS								
V_{SD}	Diode forward voltage	$I_{DS} = 4\text{ A}, V_{GS} = 0\text{ V}$			0.80	1.0	1.0	V
Q_{rr}	Reverse recovery charge	$V_{DS} = 15\text{ V}, I_F = 4\text{ A}, di/dt = 300\text{ A}/\mu\text{s}$			10	10	10	nC
t_{rr}	Reverse recovery time				11	11	11	ns

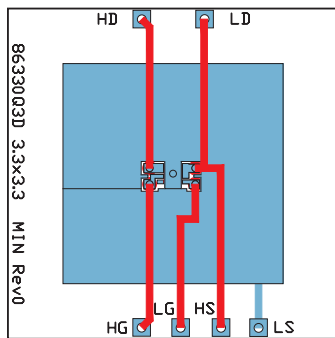

M0205-01

Max $R_{\theta JA} = 80^\circ\text{C}/\text{W}$
 when mounted on 1 in²
 (6.45 cm²) of 2-oz
 (0.071-mm) thick Cu.

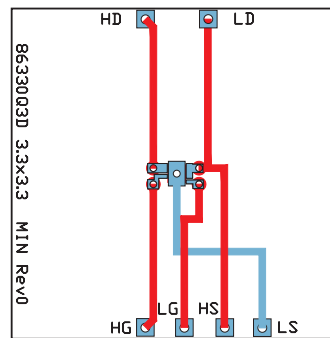

M0206-01

Max $R_{\theta JA} = 150^\circ\text{C}/\text{W}$
 when mounted on
 minimum pad area of
 2-oz (0.071-mm) thick
 Cu.

5.6 Typical Power Block Device Characteristics

The typical power block system characteristic curves (Figure 1 through Figure 9) are based on measurements made on a PCB design with dimensions of 4 in (W) × 3.5 in (L) × 0.062 in (H) and 6 copper layers of 1-oz copper thickness. See Applications for detailed explanation. $T_A = 125^\circ\text{C}$, unless stated otherwise.

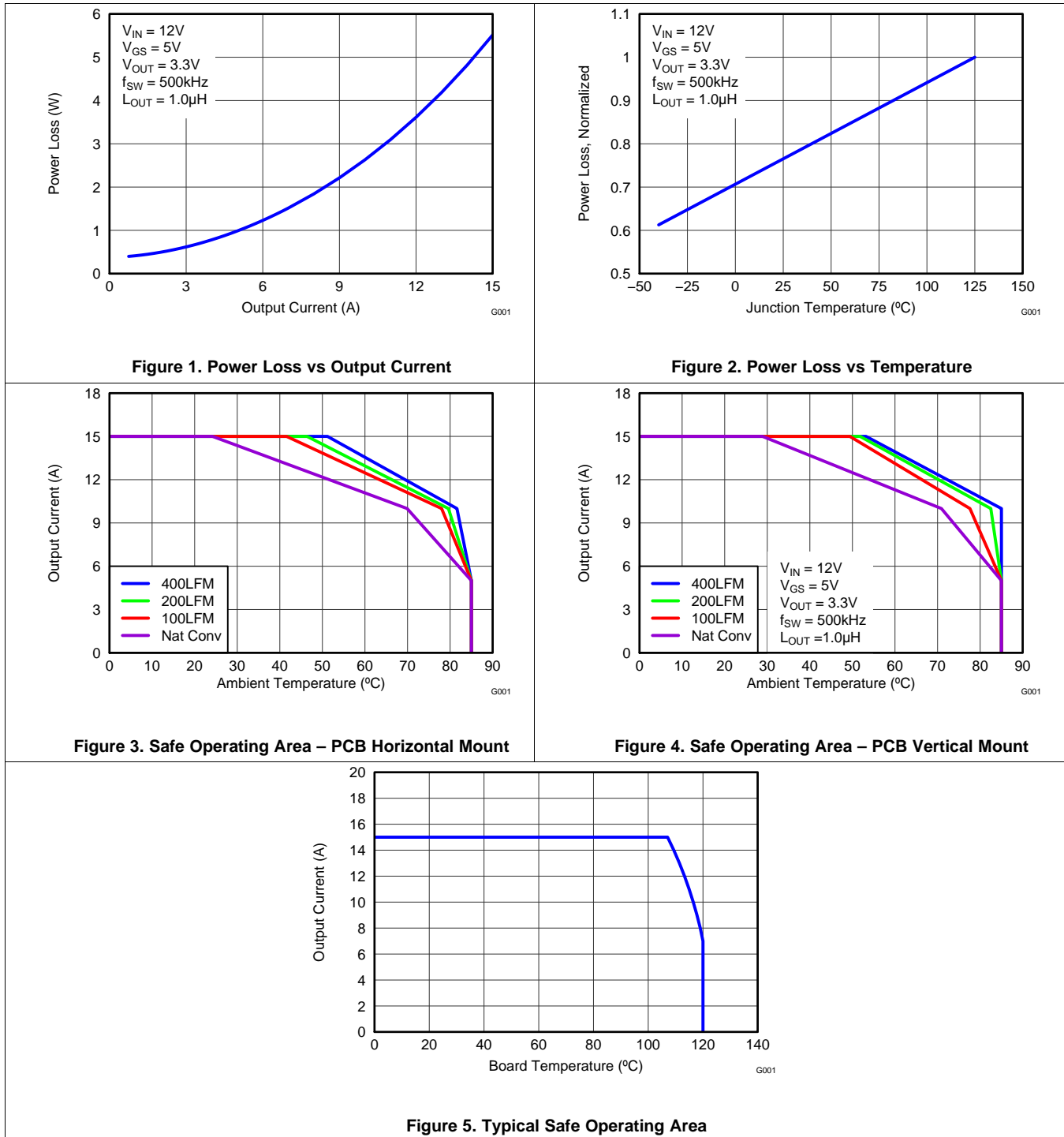

Typical Power Block Device Characteristics (continued)

The typical power block system characteristic curves (Figure 1 through Figure 9) are based on measurements made on a PCB design with dimensions of 4 in (W) × 3.5 in (L) × 0.062 in (H) and 6 copper layers of 1-oz copper thickness. See Applications for detailed explanation. $T_A = 125^\circ\text{C}$, unless stated otherwise.

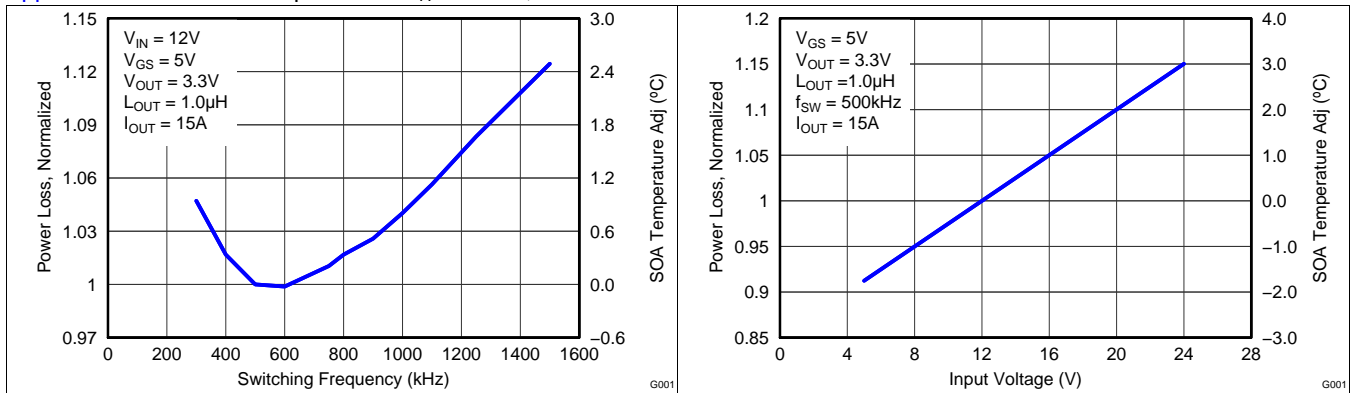

Figure 6. Normalized Power Loss vs Switching Frequency

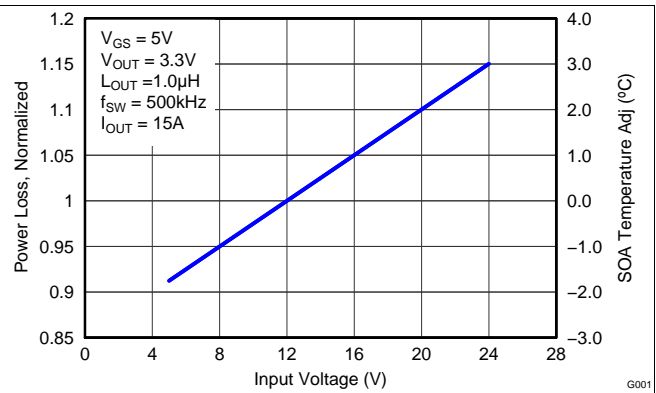

Figure 7. Normalized Power Loss vs Input Voltage

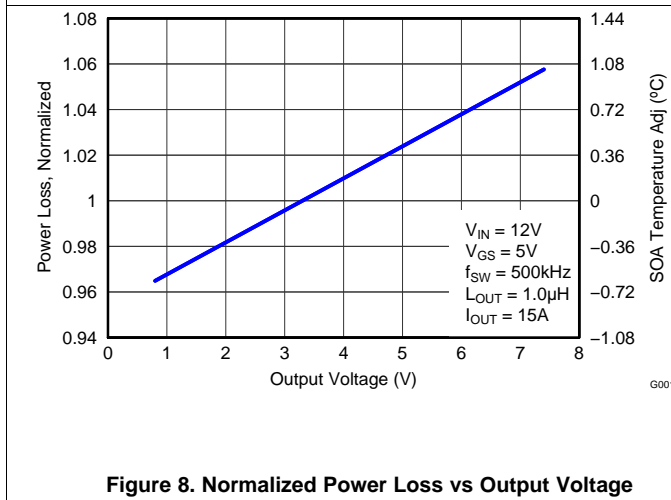

Figure 8. Normalized Power Loss vs Output Voltage

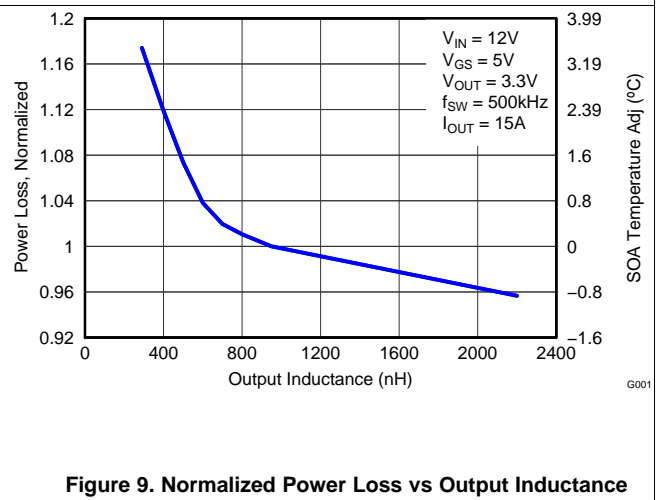

Figure 9. Normalized Power Loss vs Output Inductance

5.7 Typical Power Block MOSFET Characteristics

$T_A = 25^\circ\text{C}$, unless stated otherwise.

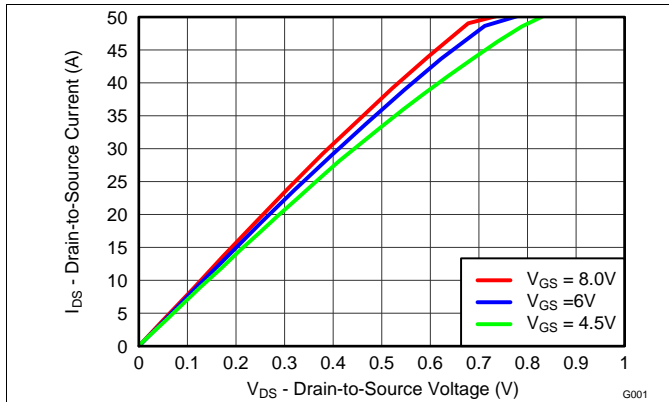

Figure 10. MOSFET Saturation Characteristics

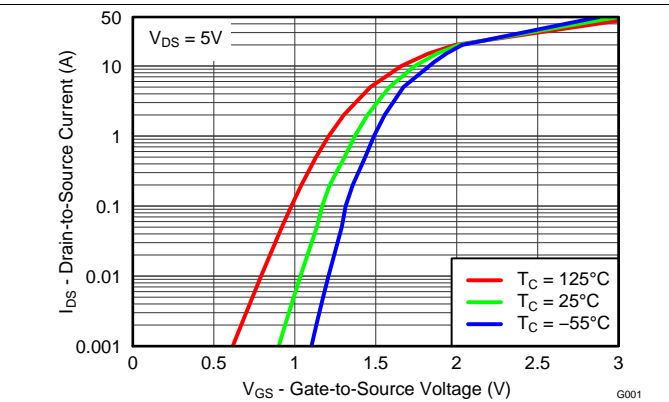

Figure 11. MOSFET Transfer Characteristics

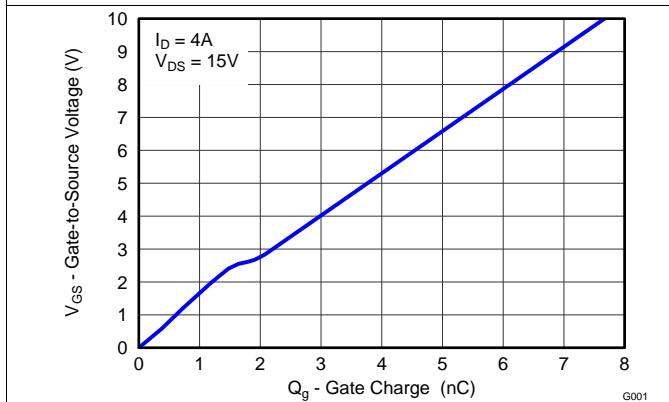

Figure 12. MOSFET Gate Charge

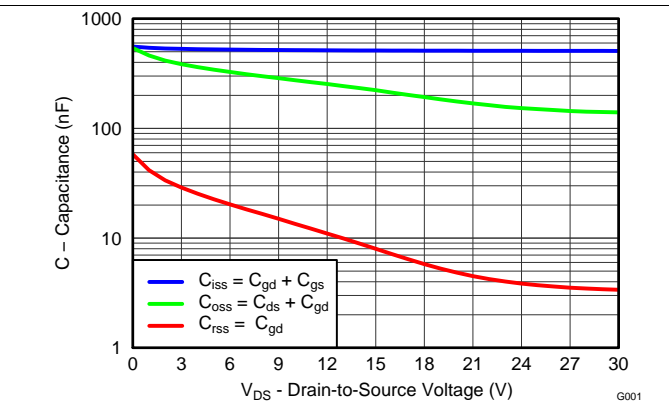

Figure 13. MOSFET Capacitance

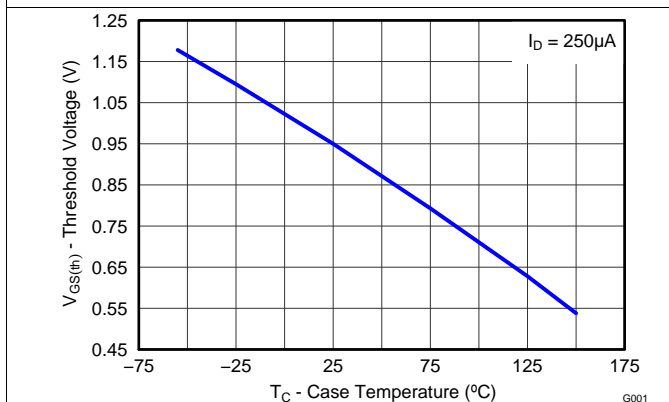

Figure 14. MOSFET $V_{GS(th)}$

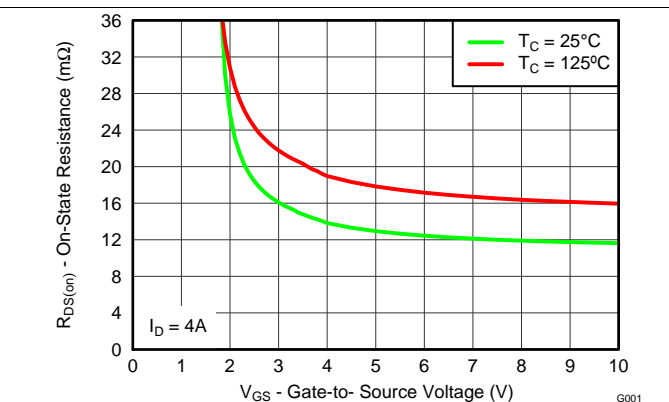
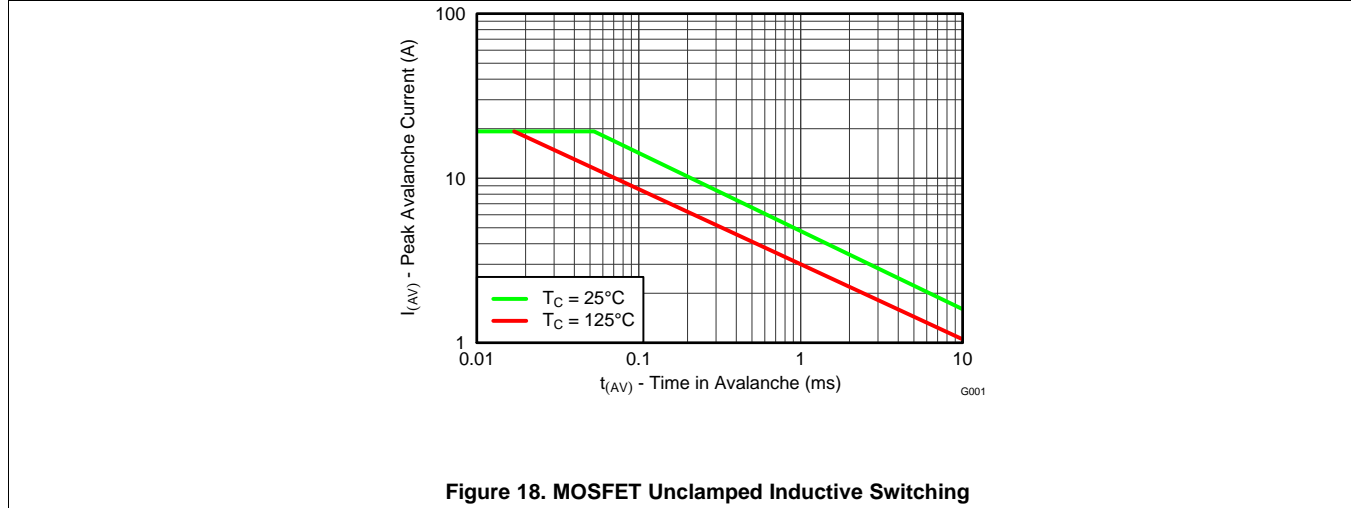
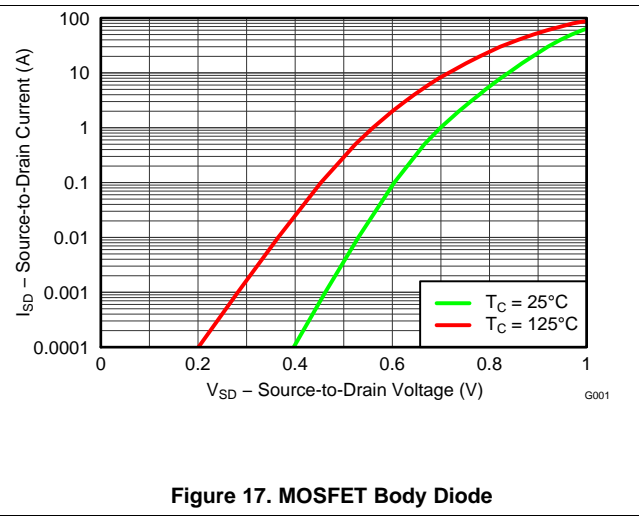
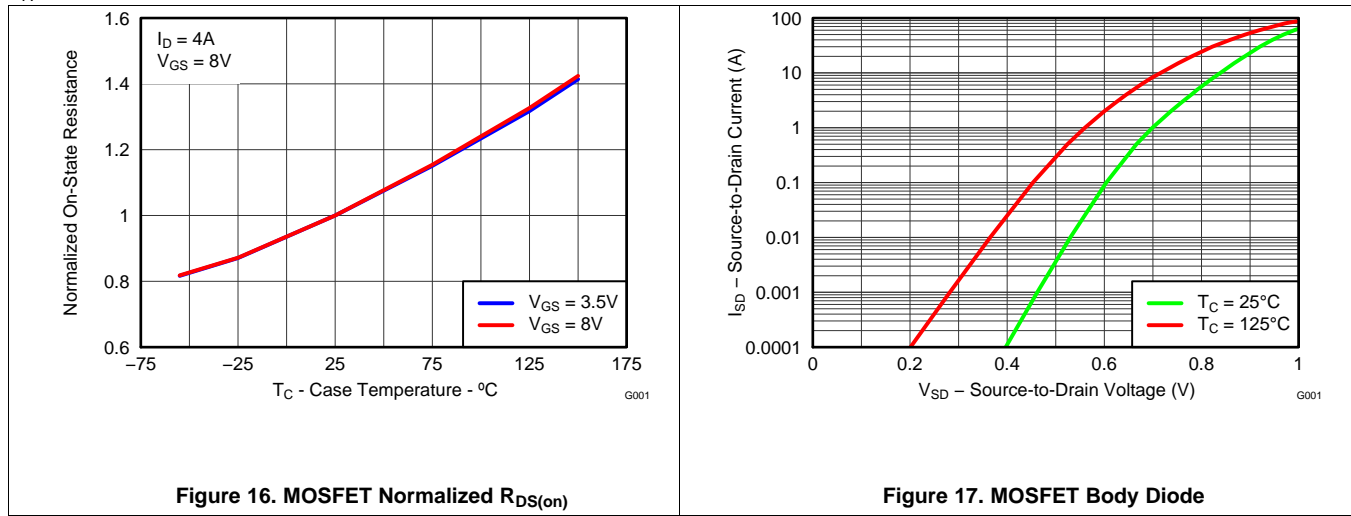

Figure 15. MOSFET $R_{DS(on)}$ vs V_{GS}

Typical Power Block MOSFET Characteristics (continued)

$T_A = 25^\circ\text{C}$, unless stated otherwise.



6 Applications

The CSD87333Q3D NexFET power block is an optimized design for synchronous buck applications using 5-V gate drive. The control FET and sync FET silicon are parametrically tuned to yield the lowest power loss and highest system efficiency. As a result, a new rating method is needed which is tailored towards a more systems-centric environment. System-level performance curves such as power loss, SOA, and normalized graphs allow engineers to predict the product performance in the actual application.

6.1 Power Loss Curves

MOSFET centric parameters such as $R_{DS(ON)}$ and Q_{gd} are needed to estimate the loss generated by the devices. In an effort to simplify the design process for engineers, Texas Instruments has provided measured power loss performance curves. Figure 1 plots the power loss of the CSD87333Q3D as a function of load current. This curve is measured by configuring and running the CSD87333Q3D as it would be in the final application (see Figure 19). The measured power loss is the CSD87333Q3D loss and consists of both input conversion loss and gate drive loss. Equation 1 is used to generate the power loss curve.

$$\text{Power loss} = (V_{IN} \times I_{IN}) + (V_{DD} \times I_{DD}) - (V_{SW_AVG} \times I_{OUT}) \quad (1)$$

The power loss curve in Figure 1 is measured at the maximum recommended junction temperatures of 125°C under isothermal test conditions.

6.2 Safe Operating Area (SOA) Curves

The SOA curves in the CSD87333Q3D data sheet provides guidance on the temperature boundaries within an operating system by incorporating the thermal resistance and system power loss. Figure 3 to Figure 5 outline the temperature and airflow conditions required for a given load current. The area under the curve dictates the safe operating area. All the curves are based on measurements made on a PCB design with dimensions of 4 in (W) × 3.5 in (L) × 0.062 in (T) and 6 copper layers of 1-oz copper thickness.

6.3 Normalized Curves

The normalized curves in the CSD87333Q3D data sheet provides guidance on the power loss and SOA adjustments based on their application specific needs. These curves show how the power loss and SOA boundaries adjust for a given set of system conditions. The primary Y-axis is the normalized change in power loss, and the secondary Y-axis is the change in system temperature required in order to comply with the SOA curve. The change in power loss is a multiplier for the power loss curve and the change in temperature is subtracted from the SOA curve.

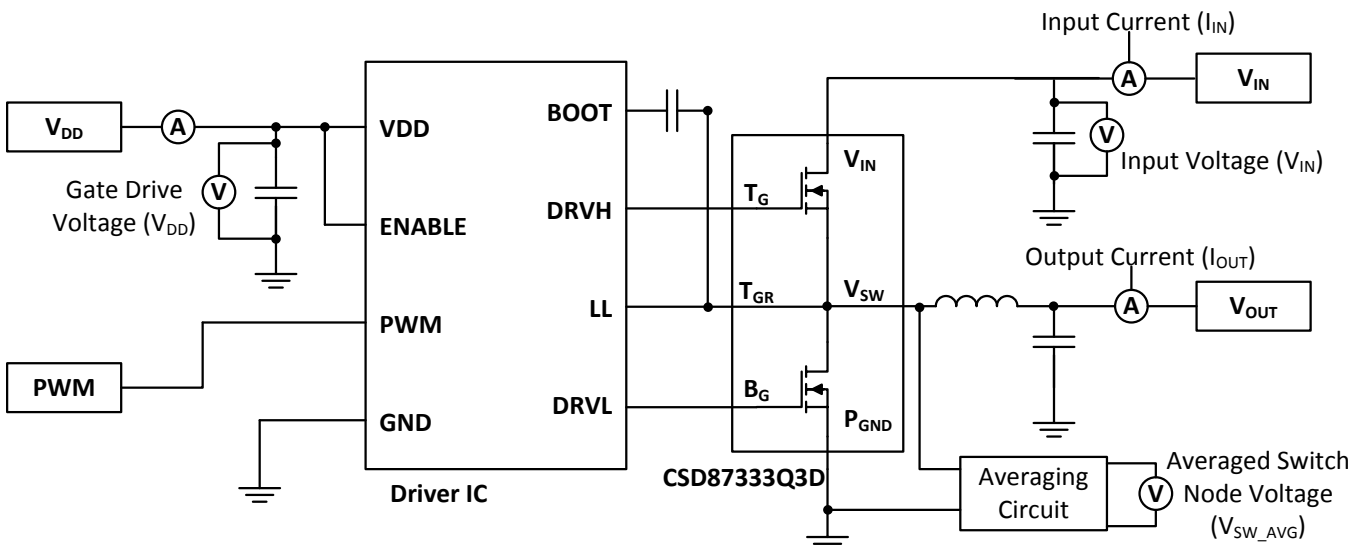

Figure 19. Typical Application

6.4 Calculating Power Loss and SOA

The user can estimate product loss and SOA boundaries by arithmetic means (see [Design Example](#)). Though the power loss and SOA curves in this data sheet are taken for a specific set of test conditions, the following procedure outlines the steps the user should take to predict product performance for any set of system conditions.

6.4.1 Design Example

Operating conditions:

- Output current = 10 A
- Input voltage = 20 V
- Output voltage = 1 V
- Switching frequency = 1000 kHz
- Inductor = 0.6 μ H

6.4.2 Calculating Power Loss

- Power loss at 10 A = 2.6 W ([Figure 1](#))
- Normalized power loss for input voltage \approx 1.1 ([Figure 7](#))
- Normalized power loss for output voltage \approx 0.96 ([Figure 8](#))
- Normalized power loss for switching frequency \approx 1.04 ([Figure 6](#))
- Normalized power loss for output inductor \approx 1.03 ([Figure 9](#))
- **Final calculated power loss = 2.6 W \times 1.1 \times 0.96 \times 1.04 \times 1.03 \approx 2.9 W**

6.4.3 Calculating SOA Adjustments

- SOA adjustment for input voltage \approx 2°C ([Figure 7](#))
- SOA adjustment for output voltage \approx - 0.2°C ([Figure 8](#))
- SOA adjustment for switching frequency \approx 0.8°C ([Figure 6](#))
- SOA adjustment for output inductor \approx 0.8°C ([Figure 9](#))
- **Final calculated SOA adjustment = 2 + (-0.2) + 0.8 + 0.8 \approx 3.4°C**

In the [Design Example](#), the estimated power loss of the CSD87333Q3D would increase to 2.9 W. In addition, the maximum allowable board or ambient temperature, or both, would have to decrease by 3.4°C. [Figure 20](#) graphically shows how the SOA curve would be adjusted accordingly.

1. Start by drawing a horizontal line from the application current to the SOA curve.
2. Draw a vertical line from the SOA curve intercept down to the board or ambient temperature.
3. Adjust the SOA board or ambient temperature by subtracting the temperature adjustment value.

In the design example, the SOA temperature adjustment yields a reduction in allowable board/ambient temperature of 3.4°C. In the event the adjustment value is a negative number, subtracting the negative number would yield an increase in allowable board or ambient temperature.

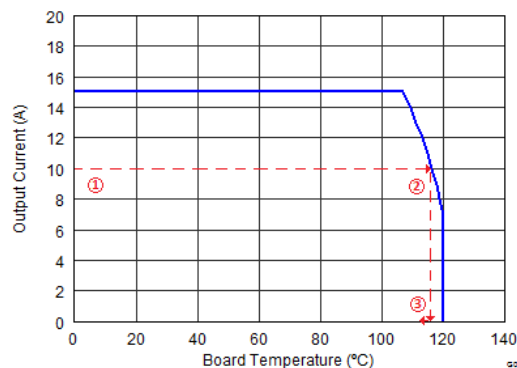

Figure 20. Power Block SOA

7 Recommended PCB Design Overview

There are two key system-level parameters that can be addressed with a proper PCB design: electrical and thermal performance. Properly optimizing the PCB layout yields maximum performance in both areas. A brief description on how to address each parameter is provided.

7.1 Electrical Performance

The power block has the ability to switch voltages at rates greater than 10 kV/μs. Special care must be then taken with the PCB layout design and placement of the input capacitors, driver IC, and output inductor.

- The placement of the input capacitors relative to the power block's VIN and PGND pins should have the highest priority during the component placement routine. It is critical to minimize these node lengths. As such, ceramic input capacitors need to be placed as close as possible to the VIN and PGND pins (see [Figure 21](#)). The example in [Figure 21](#) uses 6 × 10-μF ceramic capacitors (TDK part number C3216X5R1C106KT or equivalent). Notice there are ceramic capacitors on both sides of the board with an appropriate amount of vias interconnecting both layers. In terms of priority of placement next to the power block, C5, C7, C19, and C8 should follow in order.
 - The driver IC should be placed relatively close to the power block gate pins. T_G and B_G should connect to the outputs of the driver IC. The T_{GR} pin serves as the return path of the high-side gate drive circuitry and should be connected to the phase pin of the IC (sometimes called LX, LL, SW, PH, and so forth). The bootstrap capacitor for the driver IC will also connect to this pin.
 - The switching node of the output inductor should be placed relatively close to the power block VSW pins. Minimizing the node length between these two components will reduce the PCB conduction losses and actually reduce the switching noise level.⁽¹⁾ In the event the switch node waveform exhibits ringing that reaches undesirable levels, the use of a boost resistor or RC snubber can be an effective way to easily reduce the peak ring level. The recommended boost resistor value will range between 1 Ω to 4.7 Ω depending on the output characteristics of driver IC used in conjunction with the power block. The RC snubber values can range from 0.5 Ω to 2.2 Ω for the R and 330 pF to 2200 pF for the C. Please refer to [Snubber Circuits: Theory, Design and Application](#) (SLUP100) for more details on how to properly tune the RC snubber values. The RC snubber should be placed as close as possible to the Vsw node and PGND (see [Figure 21](#)).⁽¹⁾
- (1) Keong W. Kam, David Pommerenke, "EMI Analysis Methods for Synchronous Buck Converter EMI Root Cause Analysis", University of Missouri – Rolla

7.1 Thermal Performance

The power block has the ability to utilize the GND planes as the primary thermal path. As such, the use of thermal vias is an effective way to pull away heat from the device and into the system board. Concerns of solder voids and manufacturability problems can be addressed by the use of three basic tactics to minimize the amount of solder attach that will wick down the via barrel:

- Intentionally space out the vias from each other to avoid a cluster of holes in a given area.
- Use the smallest drill size allowed in your design. The example in [Figure 21](#) uses vias with a 10-mil drill hole and a 16-mil capture pad.
- Tent the opposite side of the via with solder-mask.

The number and drill size of the thermal vias should align with the end user's PCB design rules and manufacturing capabilities.

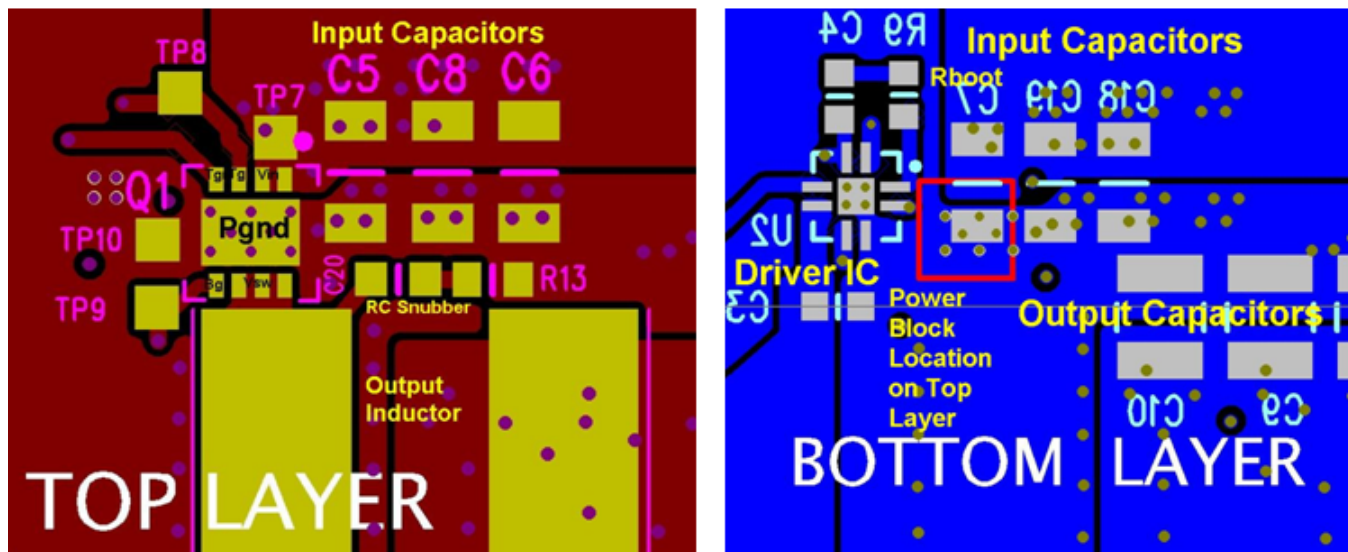

Figure 21. Recommended PCB Layout (Top Down)

8 器件和文档支持

8.1 接收文档更新通知

如需接收文档更新通知，请访问 www.ti.com.cn 网站上的器件产品文件夹。点击右上角的提醒我 (Alert me) 注册后，即可每周定期收到已更改的产品信息。有关更改的详细信息，请查阅已修订文档中包含的修订历史记录。

8.2 社区资源

The following links connect to TI community resources. Linked contents are provided "AS IS" by the respective contributors. They do not constitute TI specifications and do not necessarily reflect TI's views; see TI's [Terms of Use](#).

TI E2E™ Online Community *TI's Engineer-to-Engineer (E2E) Community*. Created to foster collaboration among engineers. At e2e.ti.com, you can ask questions, share knowledge, explore ideas and help solve problems with fellow engineers.

Design Support *TI's Design Support* Quickly find helpful E2E forums along with design support tools and contact information for technical support.

8.3 商标

NexFET, E2E are trademarks of Texas Instruments.
All other trademarks are the property of their respective owners.

8.4 静电放电警告



这些装置包含有限的内置 ESD 保护。存储或装卸时，应将导线一起截短或将装置放置于导电泡棉中，以防止 MOS 门极遭受静电损伤。

8.5 Glossary

[SLYZ022](#) — *TI Glossary*.

This glossary lists and explains terms, acronyms, and definitions.

9 机械、封装和可订购信息

以下页中包括机械封装和可订购信息。这些信息是针对指定器件可提供的最新数据。这些数据会在无通知且不对本文档进行修订的情况下发生改变。要获得这份数据表的浏览器版本，请查阅左侧的导航栏。

9.1 Q3D 封装尺寸

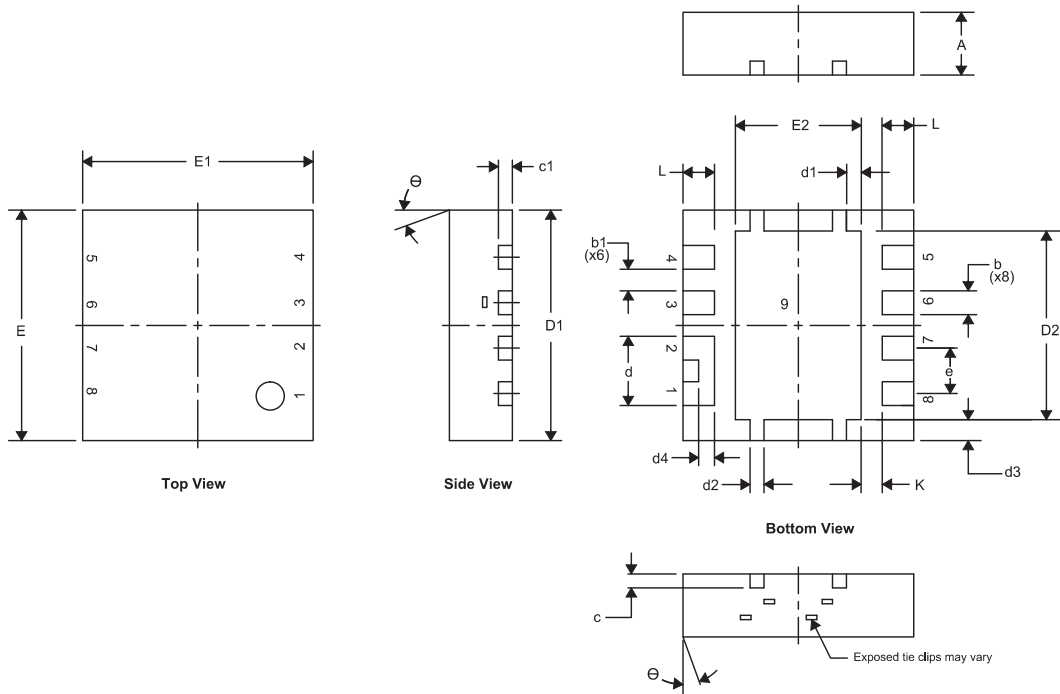

DIM	毫米		英寸	
	最小值	最大值	最小值	最大值
A	0.850	1.050	0.033	0.041
b	0.280	0.400	0.011	0.016
b1	0.310 (标称值)		0.012 (标称值)	
c	0.150	0.250	0.006	0.010
c1	0.150	0.250	0.006	0.010
d	0.940	1.040	0.037	0.041
d1	0.160	0.260	0.006	0.010
d2	0.150	0.250	0.006	0.010
d3	0.250	0.350	0.010	0.014
d4	0.175	0.275	0.007	0.011
D1	3.200	3.400	0.126	0.134
D2	2.650	2.750	0.104	0.108
E	3.200	3.400	0.126	0.134
E1	3.200	3.400	0.126	0.134
E2	1.750	1.850	0.069	0.073
e	0.650 典型值		0.026 典型值	
L	0.400	0.500	0.016	0.020
θ	0.000	—	—	—
K	0.300 典型值		0.012 典型值	

9.2 引脚布局配置

表 1. 引脚布局配置

位置	名称
引脚 1	V_{IN}
引脚 2	V_{IN}
引脚 3	T_G
引脚 4	T_{GR}
引脚 5	B_G
引脚 6	V_{SW}
引脚 7	V_{SW}
引脚 8	V_{SW}
引脚 9	P_{GND}

9.3 焊盘布局建议

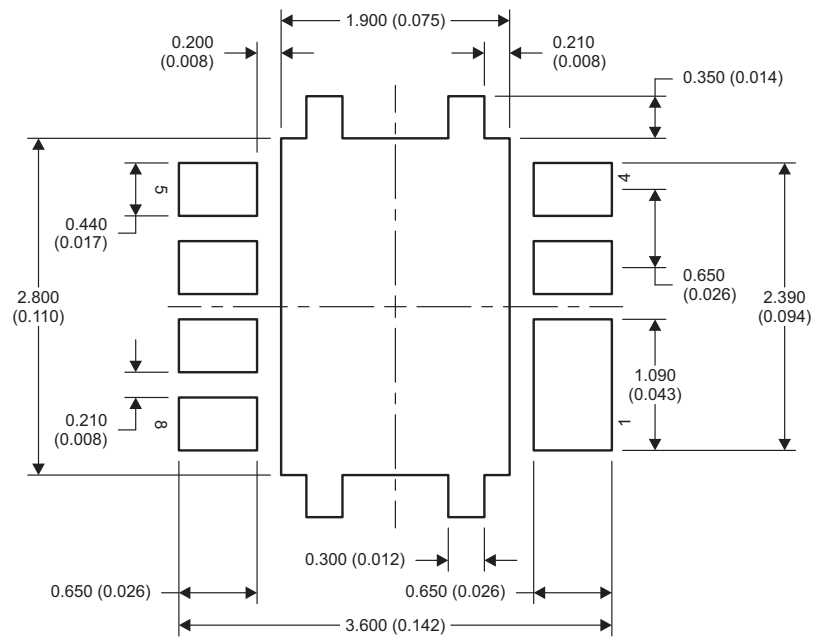

M0193-01

NOTE: 尺寸单位为 mm (英寸)。

9.4 模板建议

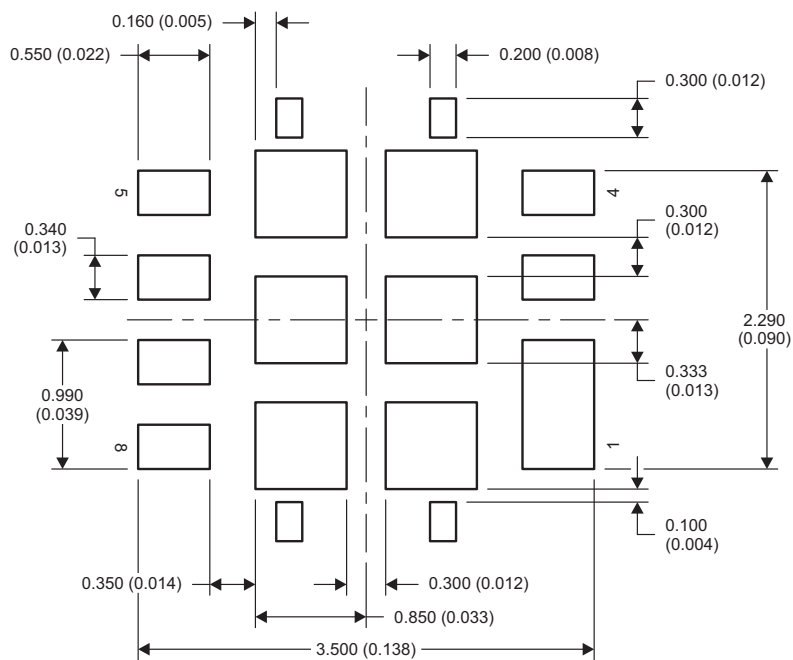

M0207-01

NOTE: 尺寸单位为 mm (英寸)。

有关针对 PCB 设计的建议电路布局布线, 请参见《[通过 PCB 布局布线技巧来减少振铃](#)》(文献编号: SLPA005)。

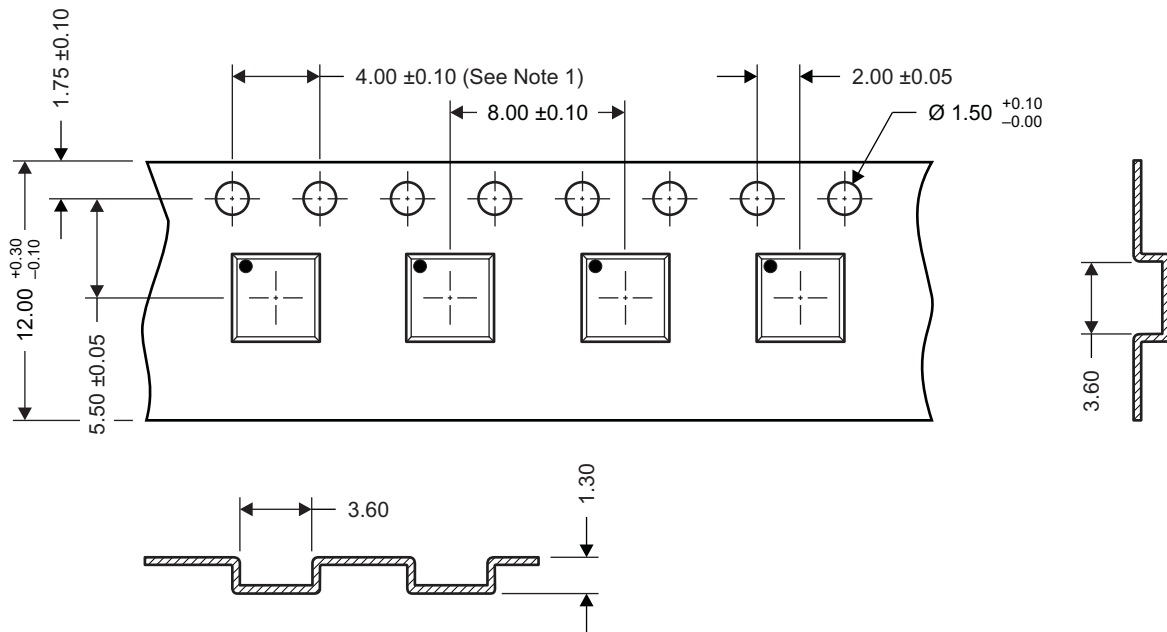

9.5 Q3D 卷带信息



M0144-01

- NOTES: 1. 10 链齿孔距累积容差 ± 0.2 。
2. 每 100mm 长度的翘曲不能超过 1mm, 250mm 长度的非累积量 (Camber not to exceed 1 mm in 100 mm, noncumulative over 250 mm)。
3. 材料: 黑色抗静电聚苯乙烯。
4. 全部尺寸单位为 mm, 除非另外注明。
5. 厚度: 0.3 ± 0.05 mm。
6. MSL1 260°C (红外 (IR) 和传导) PbF 回流焊兼容。

PACKAGING INFORMATION

Orderable Device	Status (1)	Package Type	Package Drawing	Pins	Package Qty	Eco Plan (2)	Lead finish/ Ball material (6)	MSL Peak Temp (3)	Op Temp (°C)	Device Marking (4/5)	Samples
CSD87333Q3D	ACTIVE	VSON-CLIP	DPB	8	2500	RoHS-Exempt & Green	NIPDAU SN	Level-1-260C-UNLIM	-55 to 150	87333D	
CSD87333Q3DT	ACTIVE	VSON-CLIP	DPB	8	250	RoHS-Exempt & Green	NIPDAU SN	Level-1-260C-UNLIM	-55 to 150	87333D	

(1) The marketing status values are defined as follows:

ACTIVE: Product device recommended for new designs.

LIFEBUY: TI has announced that the device will be discontinued, and a lifetime-buy period is in effect.

NRND: Not recommended for new designs. Device is in production to support existing customers, but TI does not recommend using this part in a new design.

PREVIEW: Device has been announced but is not in production. Samples may or may not be available.

OBSOLETE: TI has discontinued the production of the device.

(2) **RoHS:** TI defines "RoHS" to mean semiconductor products that are compliant with the current EU RoHS requirements for all 10 RoHS substances, including the requirement that RoHS substance do not exceed 0.1% by weight in homogeneous materials. Where designed to be soldered at high temperatures, "RoHS" products are suitable for use in specified lead-free processes. TI may reference these types of products as "Pb-Free".

RoHS Exempt: TI defines "RoHS Exempt" to mean products that contain lead but are compliant with EU RoHS pursuant to a specific EU RoHS exemption.

Green: TI defines "Green" to mean the content of Chlorine (Cl) and Bromine (Br) based flame retardants meet JS709B low halogen requirements of <=1000ppm threshold. Antimony trioxide based flame retardants must also meet the <=1000ppm threshold requirement.

(3) MSL, Peak Temp. - The Moisture Sensitivity Level rating according to the JEDEC industry standard classifications, and peak solder temperature.

(4) There may be additional marking, which relates to the logo, the lot trace code information, or the environmental category on the device.

(5) Multiple Device Markings will be inside parentheses. Only one Device Marking contained in parentheses and separated by a "~" will appear on a device. If a line is indented then it is a continuation of the previous line and the two combined represent the entire Device Marking for that device.

(6) Lead finish/Ball material - Orderable Devices may have multiple material finish options. Finish options are separated by a vertical ruled line. Lead finish/Ball material values may wrap to two lines if the finish value exceeds the maximum column width.

Important Information and Disclaimer:The information provided on this page represents TI's knowledge and belief as of the date that it is provided. TI bases its knowledge and belief on information provided by third parties, and makes no representation or warranty as to the accuracy of such information. Efforts are underway to better integrate information from third parties. TI has taken and continues to take reasonable steps to provide representative and accurate information but may not have conducted destructive testing or chemical analysis on incoming materials and chemicals. TI and TI suppliers consider certain information to be proprietary, and thus CAS numbers and other limited information may not be available for release.

In no event shall TI's liability arising out of such information exceed the total purchase price of the TI part(s) at issue in this document sold by TI to Customer on an annual basis.

TAPE AND REEL INFORMATION

QUADRANT ASSIGNMENTS FOR PIN 1 ORIENTATION IN TAPE

*All dimensions are nominal

Device	Package Type	Package Drawing	Pins	SPQ	Reel Diameter (mm)	Reel Width W1 (mm)	A0 (mm)	B0 (mm)	K0 (mm)	P1 (mm)	W (mm)	Pin1 Quadrant
CSD87333Q3D	VSON-CLIP	DPB	8	2500	330.0	12.4	3.6	3.6	1.2	8.0	12.0	Q1
CSD87333Q3DT	VSON-CLIP	DPB	8	250	180.0	12.4	3.6	3.6	1.2	8.0	12.0	Q1

TAPE AND REEL BOX DIMENSIONS

*All dimensions are nominal

Device	Package Type	Package Drawing	Pins	SPQ	Length (mm)	Width (mm)	Height (mm)
CSD87333Q3D	VSON-CLIP	DPB	8	2500	346.0	346.0	33.0
CSD87333Q3DT	VSON-CLIP	DPB	8	250	182.0	182.0	20.0

重要声明和免责声明

TI“按原样”提供技术和可靠性数据（包括数据表）、设计资源（包括参考设计）、应用或其他设计建议、网络工具、安全信息和其他资源，不保证没有瑕疵且不做任何明示或暗示的担保，包括但不限于对适销性、某特定用途方面的适用性或不侵犯任何第三方知识产权的暗示担保。

这些资源可供使用 TI 产品进行设计的熟练开发人员使用。您将自行承担以下全部责任：(1) 针对您的应用选择合适的 TI 产品，(2) 设计、验证并测试您的应用，(3) 确保您的应用满足相应标准以及任何其他功能安全、信息安全、监管或其他要求。

这些资源如有变更，恕不另行通知。TI 授权您仅可将这些资源用于研发本资源所述的 TI 产品的应用。严禁对这些资源进行其他复制或展示。您无权使用任何其他 TI 知识产权或任何第三方知识产权。您应全额赔偿因在这些资源的使用中对 TI 及其代表造成的任何索赔、损害、成本、损失和债务，TI 对此概不负责。

TI 提供的产品受 [TI 的销售条款](#) 或 [ti.com](#) 上其他适用条款/TI 产品随附的其他适用条款的约束。TI 提供这些资源并不会扩展或以其他方式更改 TI 针对 TI 产品发布的适用的担保或担保免责声明。

TI 反对并拒绝您可能提出的任何其他或不同的条款。

邮寄地址：Texas Instruments, Post Office Box 655303, Dallas, Texas 75265

Copyright © 2023，德州仪器 (TI) 公司