



ON Semiconductor®

<http://onsemi.com>

LB1836M

Monolithic Digital IC

Low-Saturation Bidirectional Motor Driver for Low-Voltage Drive

Overview

The LB1836M is a low-saturation two-channel bidirectional motor driver IC for use in low-voltage applications.

The LB1836M is a bipolar stepper-motor driver IC that is ideal for use in printers, FDDs, cameras and other portable devices.

Features

- Low voltage operation (2.5V min)
- Low saturation voltage (upper transistor + lower transistor residual voltage ; 0.40V typ at 400mA).
- Parallel connection (Upper transistor + lower transistor residual voltage ; 0.5V typ at 800mA).
- Separate logic power supply and motor power supply
- Brake function
- Spark killer diodes built in
- Thermal shutdown circuit built in
- Compact package (14-pin MFP)

Specifications

Absolute Maximum Ratings at $T_a = 25^\circ\text{C}$

Parameter	Symbol	Conditions	Ratings	Unit
Maximum supply voltage	$V_{CC\ max}$		-0.3 to +10.5	V
	$V_S\ max$		-0.3 to +10.5	V
Output supply voltage	V_{OUT}		$V_S + V_{SF}$	V
Input supply voltage	V_{IN}		-0.3 to +10	V
GND pin flow-out current	IGND	Per channel	1.0	A
Allowable power dissipation	$P_d\ max$	* Mounted on a board.	800	mW
Operating temperature	T_{opr}		-40 to +85	°C
Storage temperature	T_{stg}		-55 to +150	°C

* Mounted on a substrate: 30×30×1.5mm³, glass epoxy board.

Stresses exceeding Maximum Ratings may damage the device. Maximum Ratings are stress ratings only. Functional operation above the Recommended Operating Conditions is not implied. Extended exposure to stresses above the Recommended Operating Conditions may affect device reliability.

LB1836M

Allowable Operating Ranges at $T_a = 25^\circ\text{C}$

Parameter	Symbol	Conditions	Ratings	Unit
Supply voltage	V_{CC}		2.5 to 9.0	V
	V_S		1.8 to 9.0	V
Input "H"-level voltage	V_{IH}		1.8 to 9.0	V
Input "L"-level voltage	V_{IL}		-0.3 to +0.7	V

Electrical Characteristics at $T_a = 25^\circ\text{C}$, $V_{CC} = V_S = 3\text{V}$

Parameter	Symbol	Conditions	Ratings			Unit
			min	typ	max	
Supply current	I_{CC0}	$V_{IN1, 2, 3, 4} = 0\text{V}$, $I_{CC} + I_S$		0.1	10	μA
	I_{CC1}	$V_{IN1} = 3\text{V}$, $V_{IN2, 3, 4} = 0\text{V}$, $I_{CC} + I_S$		14	20	mA
	I_{CC2}	$V_{IN1, 2} = 3\text{V}$, $V_{IN3, 4} = 0\text{V}$, $I_{CC} + I_S$		22	35	mA
Output saturation voltage (upper + lower)	V_{OUT1}	$I_{OUT} = 200\text{mA}$		0.20	0.28	V
	V_{OUT2}	$I_{OUT} = 400\text{mA}$		0.40	0.60	V
	V_{OUT3}	$I_{OUT} = 400\text{mA}$, Parallel connection		0.25	0.35	V
	V_{OUT4}	$I_{OUT} = 800\text{mA}$, Parallel connection		0.50	0.70	V
Output sustain voltage	V_O (SUS)	$I_{OUT} = 400\text{mA}$	9			V
Input current	I_{IN}	$V_{IN} = 2\text{V}$, $V_{CC} = 6\text{V}$			80	μA
Spark killer diode						
Reverse current	I_S (leak)	$V_{CC1, 2} = 9\text{V}$			30	μA
Forward voltage	V_{SF}	$I_{OUT} = 400\text{mA}$			1.7	V

Package Dimensions

unit : mm (typ)

3111A

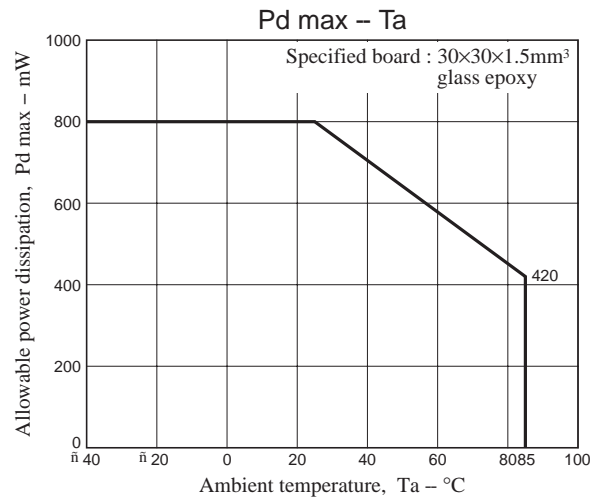
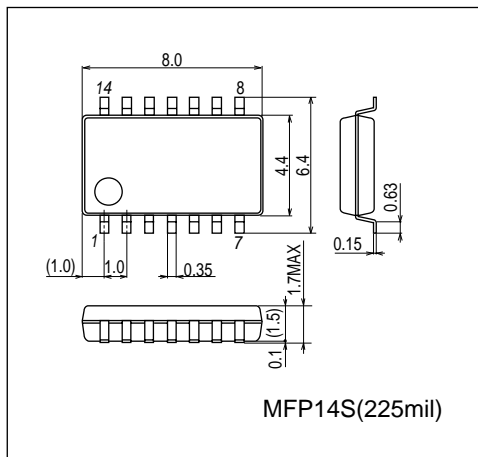

Pin Assignment

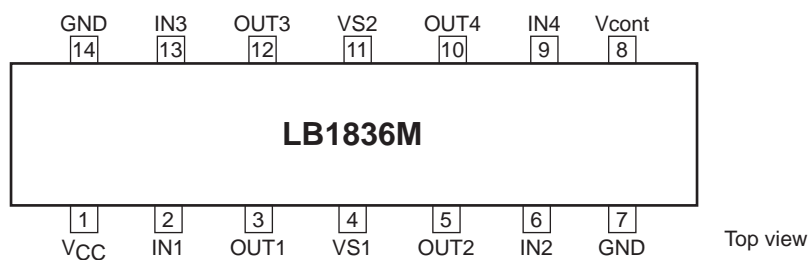

Note) Ground both GND pins.

LB1836M

Block Diagram

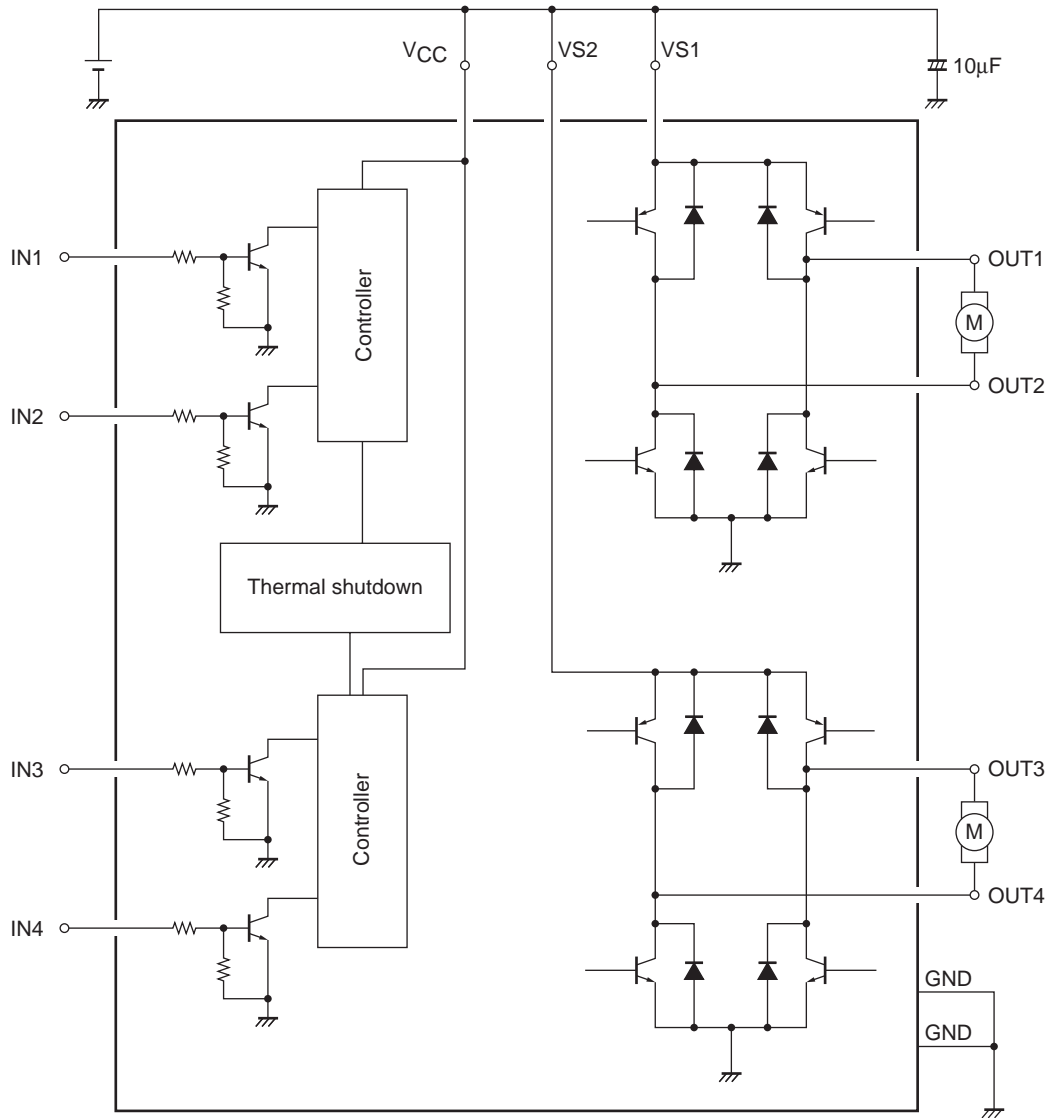

Truth Table

IN1/3	IN2/4	OUT1/3	OUT2/4	Mode
H	L	H	L	Forward
L	H	L	H	Reverse
H	H	L	L	Brake
L	L	OFF	OFF	Standby

Design Notes

If large current flows on the power supply (V_S) line and the GND line, then in some applications and layouts, misoperation due to line oscillation may result.

The modes during which large current flows are as follows :

- Motor surge current when the DC motor starts up or when it shifts rotation directions (forward \leftrightarrow reverse).
- Passthrough current generated within the IC when shifting rotation directions (forward \leftrightarrow reverse) or when shifting from forward/reverse rotation to braking, or vice versa.

The following points should be kept in mind regarding the pattern layout :

- Keep the wiring lines thick and short in order to reduce wiring inductance between the power supply (V_S) and GND.
- Insert a passthrough capacitor near the IC. (Maximum effect is obtained by inserting the passthrough capacitor between V_S and the pin 7 GND at the closest distance possible).
- If the CPU and the LB1836M are mounted on separate boards and the difference between the ground potential of each board is large, install resistors of about $10k\Omega$ in series between the CPU and the LB1836M inputs.

Vcont pin

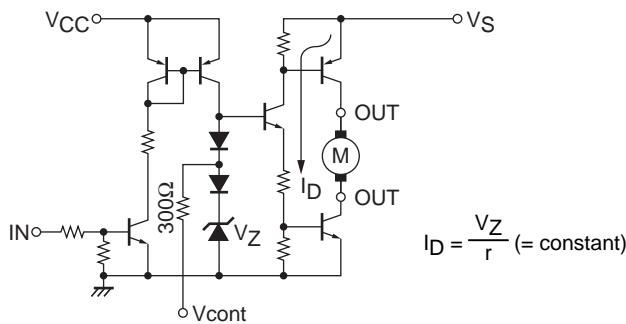

As shown in the above diagram, the Vcont pin outputs the voltage of the band gap Zener $V_Z + V_F (=1.93V)$.

In normal use, this pin is left open.

The drive current I_D is varied by the Vcont voltage. However, because the band gap Zener is shared, it functions as a bridge.

LB1836M

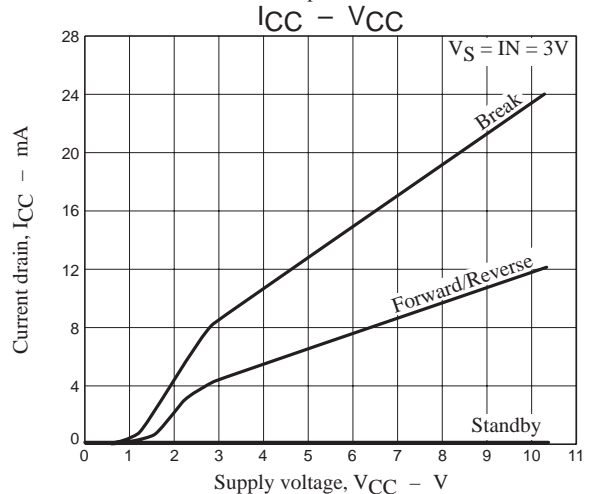
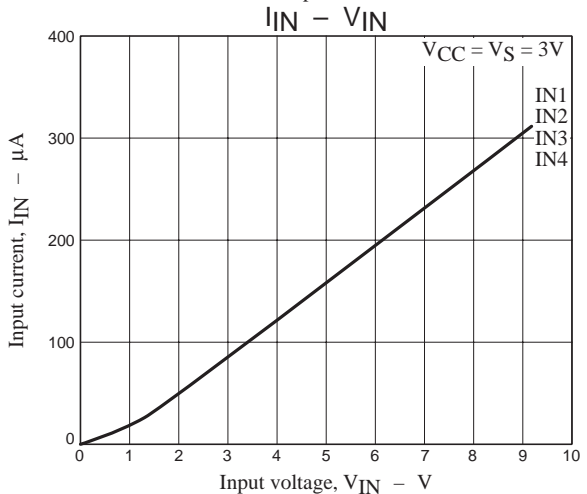
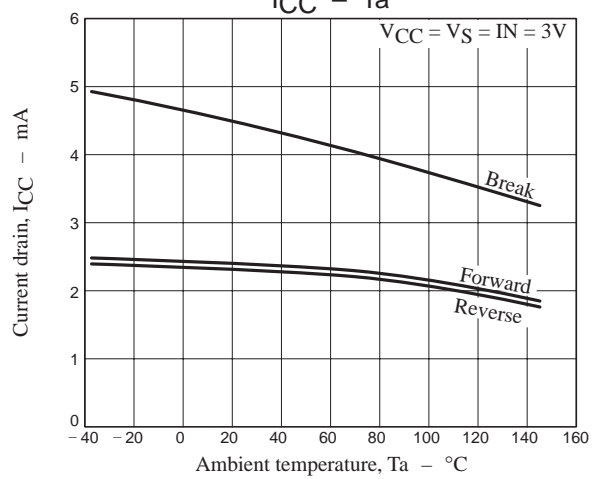
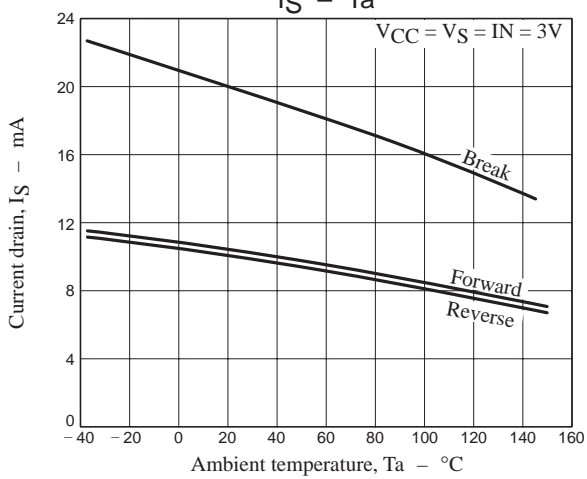
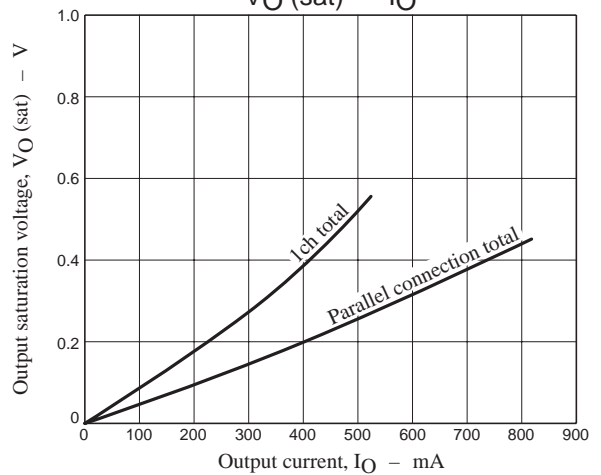
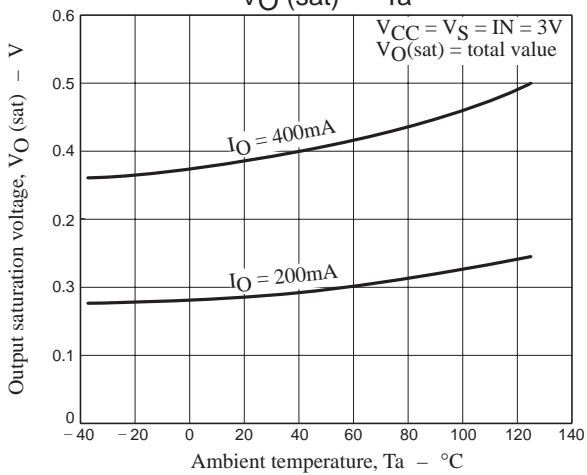
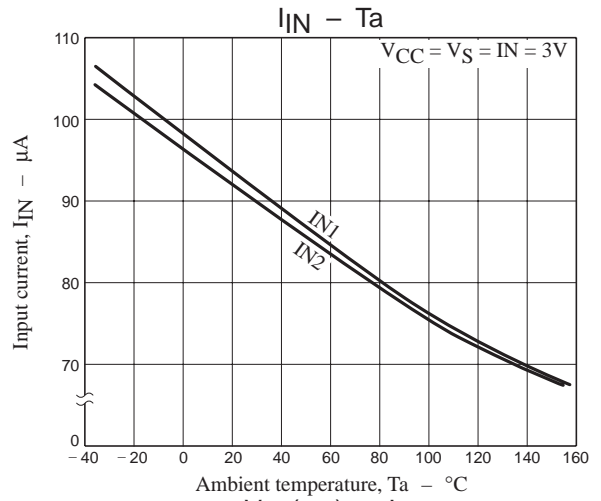
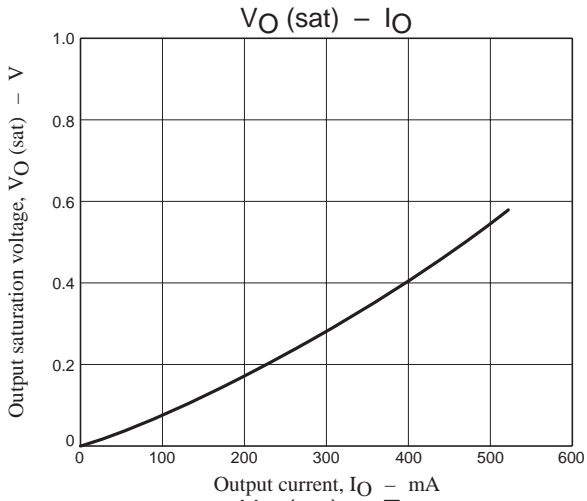

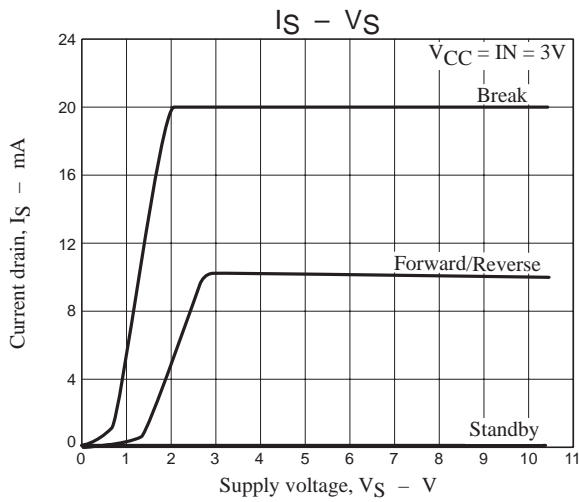

ON Semiconductor and the ON logo are registered trademarks of Semiconductor Components Industries, LLC (SCILLC). SCILLC owns the rights to a number of patents, trademarks, copyrights, trade secrets, and other intellectual property. A listing of SCILLC's product/patent coverage may be accessed at www.onsemi.com/site/pdf/Patent-Marking.pdf. SCILLC reserves the right to make changes without further notice to any products herein. SCILLC makes no warranty, representation or guarantee regarding the suitability of its products for any particular purpose, nor does SCILLC assume any liability arising out of the application or use of any product or circuit, and specifically disclaims any and all liability, including without limitation special, consequential or incidental damages. "Typical" parameters which may be provided in SCILLC data sheets and/or specifications can and do vary in different applications and actual performance may vary over time. All operating parameters, including "Typicals" must be validated for each customer application by customer's technical experts. SCILLC does not convey any license under its patent rights nor the rights of others. SCILLC products are not designed, intended, or authorized for use as components in systems intended for surgical implant into the body, or other applications intended to support or sustain life, or for any other application in which the failure of the SCILLC product could create a situation where personal injury or death may occur. Should Buyer purchase or use SCILLC products for any such unintended or unauthorized application, Buyer shall indemnify and hold SCILLC and its officers, employees, subsidiaries, affiliates, and distributors harmless against all claims, costs, damages, and expenses, and reasonable attorney fees arising out of, directly or indirectly, any claim of personal injury or death associated with such unintended or unauthorized use, even if such claim alleges that SCILLC was negligent regarding the design or manufacture of the part. SCILLC is an Equal Opportunity/Affirmative Action Employer. This literature is subject to all applicable copyright laws and is not for resale in any manner.